

iDS-2CD8426G0/F-I

DeepinView Dual-Lens Face Recognition Camera



Vsmart IPC

iDS-2CD8426G0/F-I adopts advanced deep learning algorithm and powerful GPU to realize instant face detection, capture, and comparison to accomplish face recognition and related alarm triggering.

The camera can be widely used in retail industry and security departments, such as hotel, shopping malls to improve the VIP service, custom, airport to control some key passageway.

- 1/2.8" Progressive Scan CMOS
- 1920 × 1080 @ 30fps
- 120dB WDR
- H.265+, H.265, H.264+, H.264
- 5 video streams
- Face recognition
- IR range up to 10 m



Specifications

Camera	
Image Sensor	1/2.8" Progressive Scan CMOS ×2
Min. Illumination	Color: 0.005 Lux @ (F1.2, AGC ON) Color: 0.0089 Lux @(F1.6, AGC ON) 0 Lux with IR ON
Shutter Speed	1/25 s to 1/100,000 s
Slow Shutter	No
Auto-iris	No
Day & Night	IR Cut Filter
Digital Noise Reduction	3D DNR
WDR	120 dB
2-Axis Adjustment	Tilt: -45° to 90°, rotate: 0° to 355°
Lens	
Focal length	4 mm × 2
Aperture	F1.6
FOV	4mm: horizontal FOV 85.7°
IR(/White Light /Invisible IR)	
IR Range	Up to 10 m
Compression Standard	
Video Compression	Main stream: H.265/H.264 Sub stream: H.265/H.264/MPEG4/MJPEG Third stream: H.265/H.264 Fourth stream: H.265/H.264 Fifth stream: H.265/H.264
H.264 Type	Baseline Profile/Main Profile/High Profile
H.264+	Support
H.265 Type	Main Profile
H.265+	Support
Video Bit Rate	32 Kbps to 16 Mbps
Audio Compression	G.711/G.722.1/G.726/MP2L2/PCM
Audio Bit Rate	64Kbps(G.711)/16Kbps(G.722.1)/16Kbps(G.726)/32-192Kbps(MP2L2)
Smart Feature-set	
Exception	Audio exception detection
Face Recognition	
Face Capture	Capture, automatically select and output optimum face picture.
Face Recognition	Instantly compare captured face pictures with those in face picture libraries. Recognized faces trigger alarm if alarm action is configured.
Image	
Max. Resolution	1920 × 1080
Main Stream	50Hz: 25fps (1920 × 1080, 1280 × 720) 60Hz: 30fps (1920 × 1080, 1280 × 720)
Sub Stream	50Hz: 25fps (704 × 576, 640 × 480, 352 × 288) 60Hz: 30fps (704 × 480, 640 × 480, 352 × 240)
Third Stream	50Hz: 25fps (3840 × 1080, 1280 × 720, 704 × 576, 640 × 480, 352 × 288) 60Hz: 30fps (1920 × 1080, 1280 × 720, 704 × 480, 640 × 480, 352 × 240)

Fourth Stream	50Hz: 25fps (704 × 576, 640 × 480, 352 × 288) 60Hz: 30fps (704 × 480, 640 × 480, 352 × 240)
Fifth Stream	50Hz: 25fps (704 × 576, 640 × 480, 352 × 288) 60Hz: 30fps (704 × 480, 640 × 480, 352 × 240)
Image Enhancement	BLC, HLC, defog, EIS, lens distortion correction, 3D DNR
Image Setting	Saturation, brightness, contrast, sharpness, AGC and white balance adjustable by client software or web browser
SVC	Support
Day/Night Switch	Auto/Schedule/Triggered by Alarm In
Picture Overlay	LOGO picture can be overlaid on video with 128 × 128 24bit bmp format
Network	
Network Storage	Support Micro SD/SDHC/SDXC card (128G) local storage, NAS (NFS,SMB/CIFS), ANR
Alarm Trigger	Motion detection, video tampering alarm, network disconnected, IP address conflict, illegal login, HDD full, HDD error
Protocols	TCP/IP, ICMP, HTTP, HTTPS, FTP, DHCP, DNS, DDNS, RTP, RTSP, RTCP, PPPoE, NTP, UPnP, SMTP, SNMP, IGMP, 802.1X, QoS, IPv6, UDP, Bonjour
General Function	Anti-flicker, five streams, heartbeat, mirror, password protection, privacy mask, watermark, IP address filter
API	ONVIF (PROFILE S, PROFILE G), ISAPI
Simultaneous Live View	Up to 20 channels
User/Host	Up to 32 users 3 levels: Administrator, Operator and User
Client	iVMS-4200
Web Browser	IE7+, Chrome 18-42, Firefox 5.0+, Safari 5.02+
Interface	
Audio	1 audio input (line in), 1 audio output (line out), mono soundtrack
Communication Interface	1 RJ45 10M/100M/1000M self-adaptive Ethernet port, 1 RS-485 interface
Alarm	1 input, 1 output (up to 24 VDC 1 A or 110 VAC 500 mA)
On-board storage	Built-in micro SD/SDHC/SDXC slot, up to 128 GB
Audio	
Environment Noise Filtering	Support
Audio Sampling Rate	Max. 48 kHz
General	
Operating Conditions	-10 °C to 40 °C (-14 °F to 104 °F) Humidity 95% or less (non-condensing)
Power Supply	36 VDC, two-core terminal block Power adapter included (220 VAC to 36 VDC)
Power Consumption and Current	36 VDC, max. 27 W, 0.75A
Protection Level	TVS 4000V Lightning Protection, Surge Protection and Voltage Transient Protection
Shell Material	Metal
Dimensions	180.4 × 147 × 117.9 mm (7.10" × 5.79" × 4.64")
Weight	Approx. 1500 g (3.31 lb)

Available Models

iDS-2CD8426G0/F-I

Dimensions

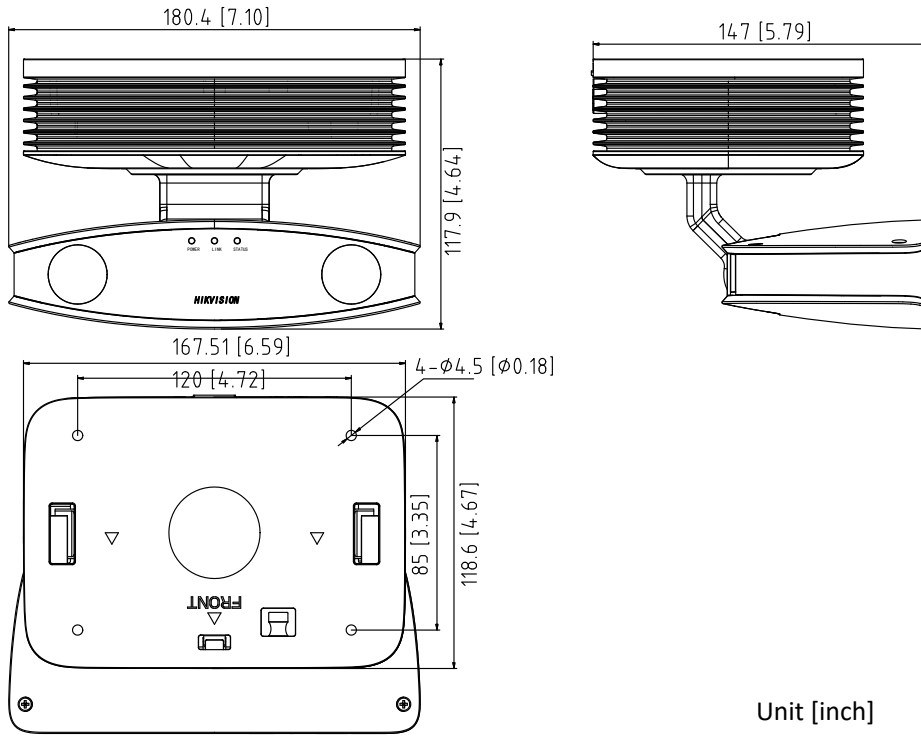

Unit [inch]

Distributed by



HIKVISION

Headquarters

No.555 Qianmo Road, Binjiang District,
Hangzhou 310051, China
T +86-571-8807-5988
overseasbusiness@hikvision.com

Hikvision USA
T +1-909-895-0400
sales.usa@hikvision.com

Hikvision Europe
T +31-23-55-42-770
info.eu@hikvision.com

Hikvision Middle East
T +971-4-8816086
salesme@hikvision.com

Hikvision Russia
T +7-495-669-67-99
saleru@hikvision.com

Hikvision India
T +91-22-28469900
sales@pramahikvision.com

Hikvision Italy
T +39-0438-6902
info.it@hikvision.com

Hikvision France
T +33(0)1-85-330-450
info.fr@hikvision.com

Hikvision Spain
T +34-91-737-16-55
info.es@hikvision.com

Hikvision Poland
T +48-22-460-01-50
poland@hikvision.com

Hikvision UK
T +01628-902140
support.uk@hikvision.com

Hikvision Singapore
T +65-6684-4718
sg@hikvision.com

Hikvision Oceania
T +61-2-8599-4233
salesau@hikvision.com

Hikvision Canada
T +1-909-895-0400
sales.usa@hikvision.com

Hikvision Korea
T +82-31-731-8841
sales.korea@hikvision.com

Hikvision Brazil
T +55 11 3318-0050
Latam.support@hikvision.com

Hikvision Africa
T +27 (10) 0351172
sale.africa@hikvision.com

Hikvision Hong Kong
T +852-2151-1761